

TOSHIBA CMOS DIGITAL INTEGRATED CIRCUIT SILICON MONOLITHIC

TC74LCX16652AFT

LOW VOLTAGE 16-BIT BUS TRANSCEIVER / REGISTER WITH 5V TOLERANT INPUTS AND OUTPUTS

The TC74LCX16652AFT is a high performance CMOS 16bit BUS TRANSCEIVER / REGISTER. Designed for use in 3.3 Volt systems, it achieves high speed operation while maintaining the CMOS low power dissipation. This device is designed for low-voltage (3.3V) V_{CC} applications, but it could be used to interface to 5V supply environment for both inputs and outputs. This device is bus transceiver with 3-state outputs, D-type flip-flops, and control circuitry arranged for multiplexed transmission of data directly from the internal registers. All inputs are equipped with protection circuits against static discharge.

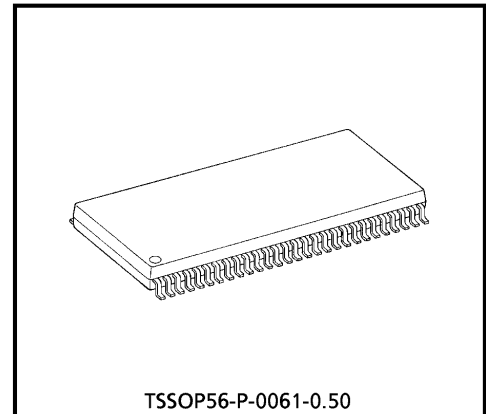

Weight : 0.25g (Typ.)

FEATURES

- Low voltage operation : $V_{CC} = 2.0 \sim 3.6V$
- High speed operation : $t_{pd} = 6.0ns$ (Max.) ($V_{CC} = 3.0 \sim 3.6V$)
- Output current : $|I_{OH}| / |I_{OL}| = 24mA$ (Min.) ($V_{CC} = 3.0V$)
- Latch-up performance : $\pm 500mA$
- Package : TSSOP (Thin Shrink Small Outline Package)
- Bidirectional interface between 5V and 3.3V signals.
- Power down protection is provided on all inputs and outputs.

(Note) Do not apply a signal to any bus terminal when it is in the output mode. Damage may result.

All floating (high impedance) bus terminals must have their input levels fixed by means of pull up or pull down resistors.

961001EBA2

- TOSHIBA is continually working to improve the quality and the reliability of its products. Nevertheless, semiconductor devices in general can malfunction or fail due to their inherent electrical sensitivity and vulnerability to physical stress. It is the responsibility of the buyer, when utilizing TOSHIBA products, to observe standards of safety, and to avoid situations in which a malfunction or failure of a TOSHIBA product could cause loss of human life, bodily injury or damage to property. In developing your designs, please ensure that TOSHIBA products are used within specified operating ranges as set forth in the most recent products specifications. Also, please keep in mind the precautions and conditions set forth in the TOSHIBA Semiconductor Reliability Handbook.
- The products described in this document are subject to foreign exchange and foreign trade control laws.
- The information contained herein is presented only as a guide for the applications of our products. No responsibility is assumed by TOSHIBA CORPORATION for any infringements of intellectual property or other rights of the third parties which may result from its use. No license is granted by implication or otherwise under any intellectual property or other rights of TOSHIBA CORPORATION or others.
- The information contained herein is subject to change without notice.

PIN ASSIGNMENT

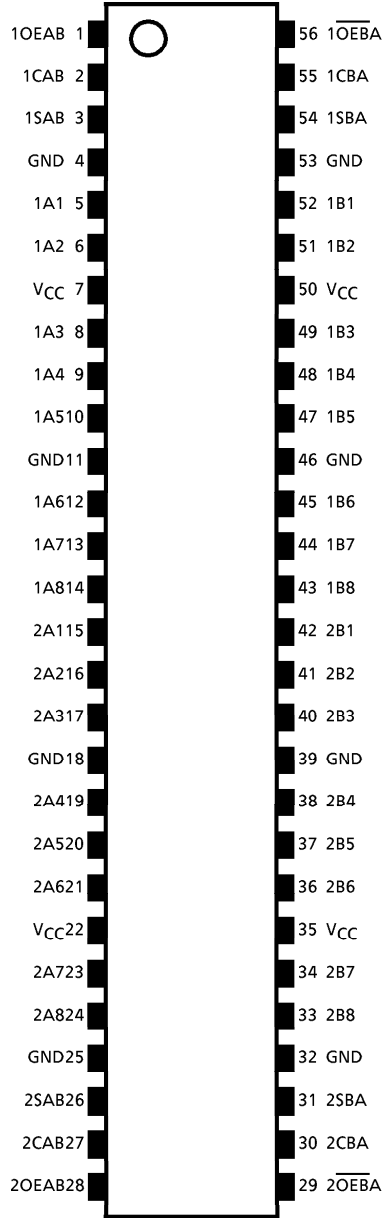





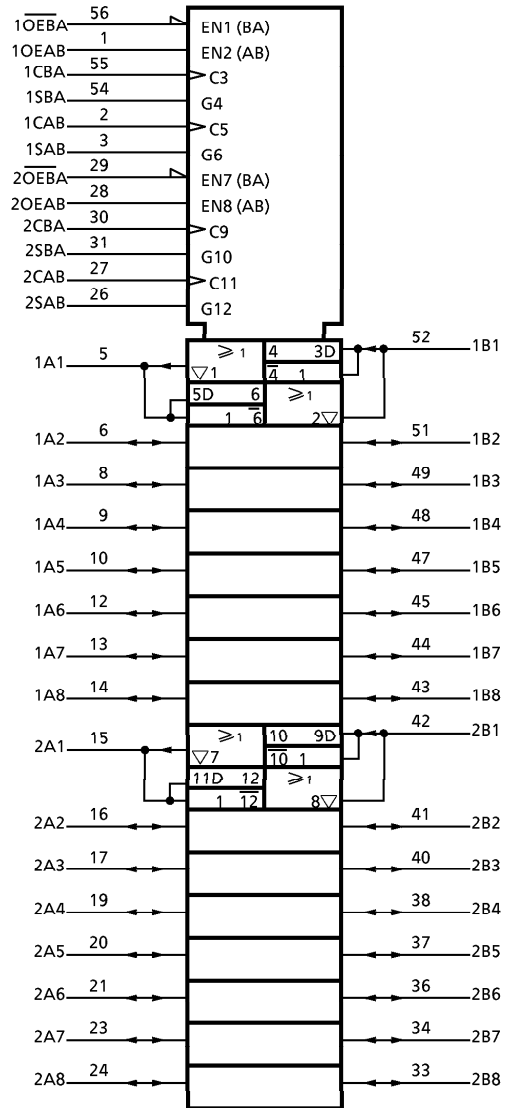

(TOP VIEW)

IEC LOGIC SYMBOL



TRUTH TABLE

CONTROL INPUTS						BUS		FUNCTION	
OEAB	\overline{OEBA}	CAB	CBA	SAB	SBA	A	B		
L	H	X*	X*	X	X	INPUT Z	INPUT Z	The output functions of A and B Busses are disabled.	
				X	X	X	X	Both A and B Busses are used as inputs to the internal flip-flops. Data on the Bus will be stored on the rising edge of the Clock.	
H	H	X*	X*	L	X	INPUT L	OUTPUT L	The data on the A bus are displayed on the B bus.	
						H	H		
						L	L		
			X*	L	X	L	L	The data on the A bus are displayed on the B Bus, and are stored into the A storage flip-flops on the rising edge of CAB.	
						H	H		
						X	Qn	The data in the A storage flip-flops are displayed on the B Bus.	
	X*	H	X	L	L	The data on the A Bus are stored into the A storage flip-flops on the rising edge of CAB, and the stored data propagate directly onto the B Bus.			
				H	H				
L	L	X*	X*	X	L	OUTPUT L	INPUT L	The data on the B Bus are displayed on the A bus.	
						H	H		
						L	L		
		X*		X	L	L	L	The data on the B Bus are displayed on the A Bus, and are stored into the B storage flip-flops on the rising edge of CBA.	
						H	H		
						Qn	X	The data in the B storage flip-flops are displayed on the A Bus.	
X*		X	H	L	L	The data on the B Bus are stored into the B storage flip-flops on the rising edge of CBA, and the stored data propagate directly onto the A Bus.			
				H	H				
H	L	X*	X*	H	H	OUTPUT Qn	OUTPUT Qn	The data in the A storage flip-flops are displayed on the B Bus, and the data in the B storage flip-flops are displayed on the A.	
						Qn	Qn		

X : Don't care

Z : High Impedance

Qn : The data stored into the internal flip-flops by most recent low to high transition of the clock inputs.

* The clocks are not internally gated with either OEAB or \overline{OEBA} . Therefore, data on the A and/or B Busses may be clocked into the storage flip-flops at any time.

SYSTEM DIAGRAM

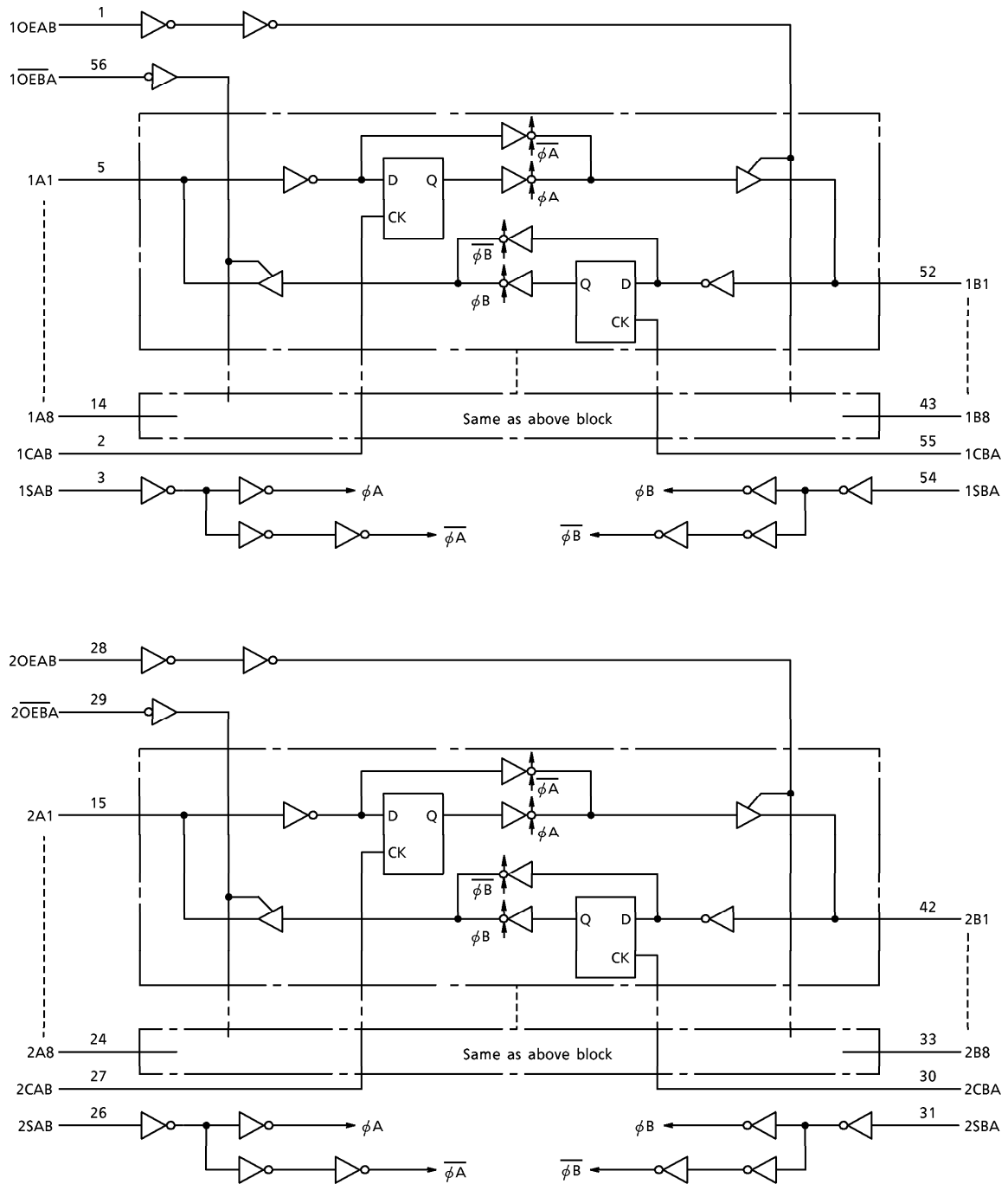

TIMING CHART

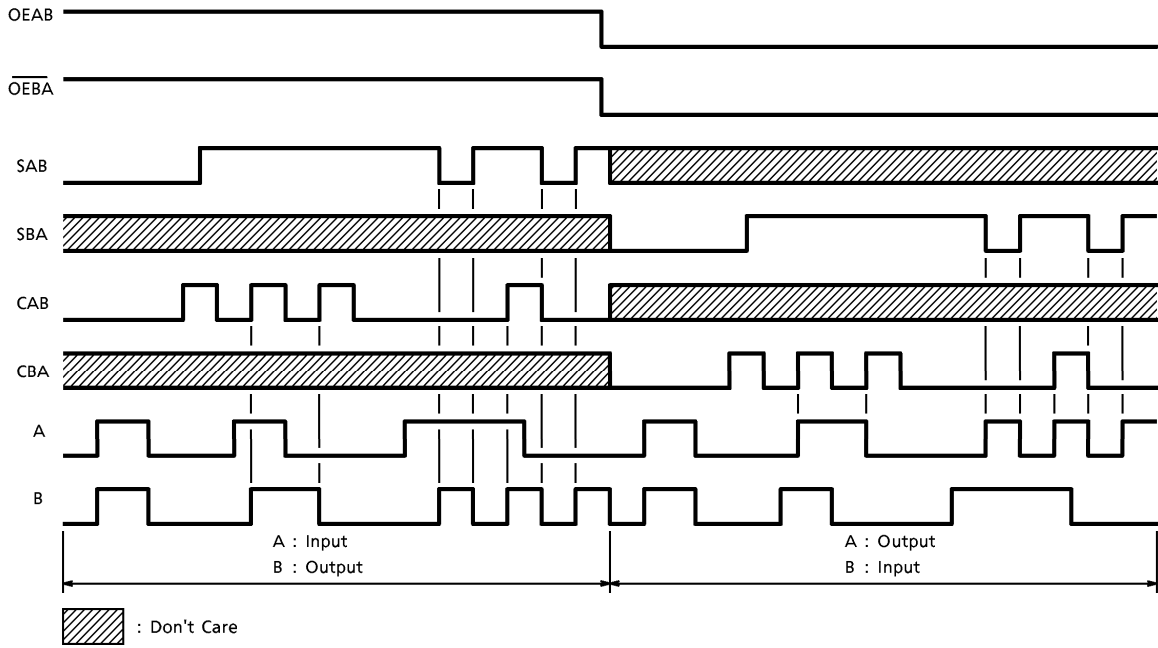

MAXIMUM RATINGS

PARAMETER	SYMBOL	RATING	UNIT
Supply Voltage Range	V_{CC}	-0.5~7.0	V
DC Input Voltage (CAB, CBA, SAB, SBA, OEAB, OEBA)	V_{IN}	-0.5~7.0	V
DC Bus I/O Voltage	$V_{I/O}$	-0.5~7.0 (Note 1)	V
		-0.5~ V_{CC} +0.5 (Note 2)	
Input Diode Current	I_{IK}	-50	mA
Output Diode Current	I_{OK}	±50 (Note 3)	mA
DC Output Current	I_{OUT}	±50	mA
Power Dissipation	P_D	400	mW
DC V_{CC} /Ground Current	I_{CC}/I_{GND}	±100	mA
Storage Temperature	T_{stg}	-65~150	°C

(Note 1) Output in Off-State

(Note 2) High or Low State. I_{OUT} absolute maximum rating must be observed.

(Note 3) $V_{OUT} < GND$, $V_{OUT} > V_{CC}$

RECOMMENDED OPERATING CONDITIONS

PARAMETER	SYMBOL	RATING	UNIT
Supply Voltage	V_{CC}	2.0~3.6	V
		1.5~3.6 (Note 4)	
Input Voltage (CAB, CBA, SAB, SBA, OEAB, OEBA)	V_{IN}	0~5.5	V
Bus I/O Voltage	$V_{I/O}$	0~5.5 (Note 5)	V
		0~ V_{CC} (Note 6)	
Output Current	I_{OH}/I_{OL}	±24 (Note 7)	mA
		±12 (Note 8)	
Operating Temperature	T_{opr}	-40~85	°C
Input Rise And Fall Time	dt/dv	0~10 (Note 9)	ns/V

(Note 4) Data Retention Only.

(Note 5) Output in Off-State

(Note 6) High or Low State.

(Note 7) $V_{CC} = 3.0\sim 3.6V$

(Note 8) $V_{CC} = 2.7\sim 3.0V$

(Note 9) $V_{IN} = 0.8\sim 2.0V$, $V_{CC} = 3.0V$

ELECTRICAL CHARACTERISTICS

DC CHARACTERISTICS (Ta = -40~85°C)

PARAMETER		SYMBOL	TEST CONDITION	V _{CC} (V)	MIN.	MAX.	UNIT	
Input Voltage	"H" Level	V _{IH}		2.7~3.6	2.0	—	V	
	"L" Level	V _{IL}		2.7~3.6	—	0.8		
Output Voltage	"H" Level	V _{OH}	V _{IN} = V _{IH} or V _{IL}	I _{OH} = -100μA	2.7~3.6	V _{CC} - 0.2	V	
				I _{OH} = -12mA	2.7	2.2		—
				I _{OH} = -18mA	3.0	2.4		—
				I _{OH} = -24mA	3.0	2.2		—
	"L" Level	V _{OL}	V _{IN} = V _{IH} or V _{IL}	I _{OL} = 100μA	2.7~3.6	—	0.2	
				I _{OL} = 12mA	2.7	—	0.4	
				I _{OL} = 16mA	3.0	—	0.4	
			I _{OL} = 24mA	3.0	—	0.55		
Input Leakage Current		I _{IN}	V _{IN} = 0~5.5V	2.7~3.6	—	±5.0	μA	
3-State Output Off-State Current		I _{OZ}	V _{IN} = V _{IH} or V _{IL} V _{OUT} = 0~5.5V	2.7~3.6	—	±5.0	μA	
Power Off Leakage Current		I _{OFF}	V _{IN} / V _{OUT} = 5.5V	0	—	10.0	μA	
Quiescent Supply Current		I _{CC}	V _{IN} = V _{CC} or GND	2.7~3.6	—	20.0	μA	
			V _{IN} / V _{OUT} = 3.6~5.5V	2.7~3.6	—	±20.0		
Increase In I _{CC} Per Input		ΔI _{CC}	V _{IH} = V _{CC} - 0.6V	2.7~3.6	—	500		

AC CHARACTERISTIC (Ta = -40~85°C)

PARAMETER	SYMBOL	TEST CONDITION	V _{CC} (V)	MIN.	MAX.	UNIT
Maximum Clock Frequency	f _{MAX}	(Fig.1, 2)	2.7	—	—	MHz
			3.3 ± 0.3	170	—	
Propagation Delay Time (An, Bn-Bn, An)	t _{pLH} t _{pHL}	(Fig.1, 2)	2.7	—	6.6	ns
			3.3 ± 0.3	1.5	6.0	
Propagation Delay Time (CAB, CBA-Bn, An)	t _{pLH} t _{pHL}	(Fig.1, 5)	2.7	—	8.3	ns
			3.3 ± 0.3	1.5	7.5	
Propagation Delay Time (SAB, SBA-Bn, An)	t _{pLH} t _{pHL}	(Fig.1, 2)	2.7	—	8.3	ns
			3.3 ± 0.3	1.5	7.5	
Output Enable Time (OEAB, OEBA-An, Bn)	t _{pZL} t _{pZH}	(Fig.1, 3, 4)	2.7	—	8.3	ns
			3.3 ± 0.3	1.5	7.5	
Output Disable Time (OEAB, OEBA-An, Bn)	t _{pLZ} t _{pHZ}	(Fig.1, 3, 4)	2.7	—	8.3	ns
			3.3 ± 0.3	1.5	7.5	
Minimum Pulse Width	t _w (H) t _w (L)	(Fig.1, 5)	2.7	4.0	—	ns
			3.3 ± 0.3	3.0	—	
Minimum Set-up Time	t _s	(Fig.1, 5)	2.7	2.5	—	ns
			3.3 ± 0.3	2.5	—	
Minimum Hold Time	t _h	(Fig.1, 5)	2.7	1.5	—	ns
			3.3 ± 0.3	1.5	—	
Output To Output Skew	t _{osLH} t _{osHL}	(Note 10)	2.7	—	—	ns
			3.3 ± 0.3	—	1.0	

(Note 10) Parameter guaranteed by design.
 (t_{osLH} = |t_{pLHm} - t_{pLHn}|, t_{osHL} = |t_{pHLm} - t_{pHLn}|)

DYNAMIC SWITCHING CHARACTERISTICS (Ta = 25°C, Input t_r = t_f = 2.5ns, C_L = 50pF, R_L = 500Ω)

PARAMETER	SYMBOL	TEST CONDITION	V _{CC} (V)	TYP.	UNIT
Quiet Output Maximum Dynamic V _{OL}	V _{OLP}	V _{IH} = 3.3V, V _{IL} = 0V (Note 11)	3.3	0.8	V
Quiet Output Minimum Dynamic V _{OL}	V _{OLV}	V _{IH} = 3.3V, V _{IL} = 0V (Note 11)	3.3	0.8	V

(Note 11) Characterized with 15 outputs switching from High-to-Low or Low-to-High.
 The remaining output is measured in the Low state.

CAPACITIVE CHARACTERISTICS (Ta = 25°C)

PARAMETER	SYMBOL	TEST CONDITION	V _{CC} (V)	TYP.	UNIT
Input Capacitance	C _{IN}	OEAB, OEBA, CAB, CBA, SAB, SBA	3.3 ± 0.3	7	pF
Bus Input Capacitance	C _{I/O}	An, Bn	3.3 ± 0.3	8	pF
Power Dissipation Capacitance	C _{PD}	f _{IN} = 10MHz (Note 12)	3.3 ± 0.3	25	pF

(Note 12) C_{PD} is defined as the value of the internal equivalent capacitance which is calculated from the operating current consumption without load.

Average operating current can be obtained by the equation :

$$I_{CC(opr.)} = C_{PD} \cdot V_{CC} \cdot f_{IN} + I_{CC} / 16 \text{ (per bit)}$$

TEST CIRCUIT

Fig.1

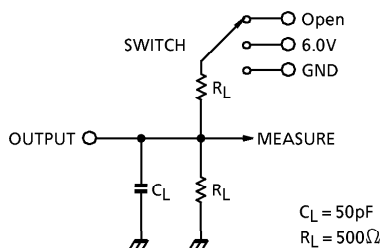

PARAMETER	SWITCH
t _{pLH} , t _{pHL}	Open
t _{pLZ} , t _{pZL}	6.0V
t _{pHZ} , t _{pZH}	GND
t _w , t _s , t _h , f _{MAX}	Open

AC WAVEFORM

Fig.2 t_{pLH} , t_{pHL}

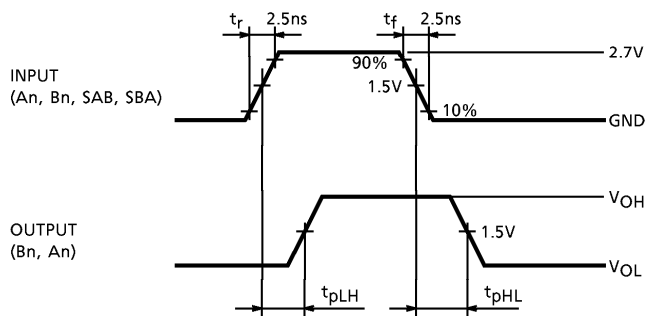

Fig.3 t_{pLZ} , t_{pHZ} , t_{pZL} , t_{pZH}

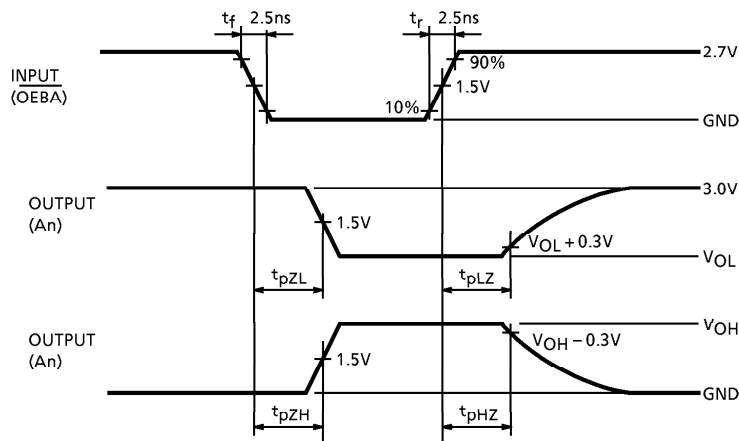

Fig.4 t_{pLZ} , t_{pHZ} , t_{pZL} , t_{pZH}

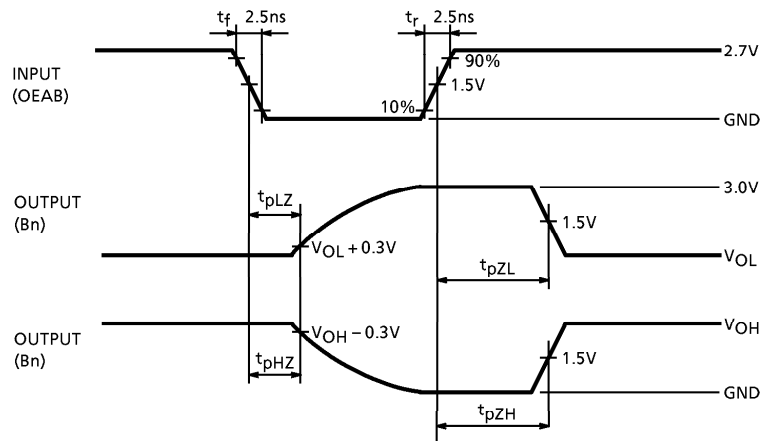
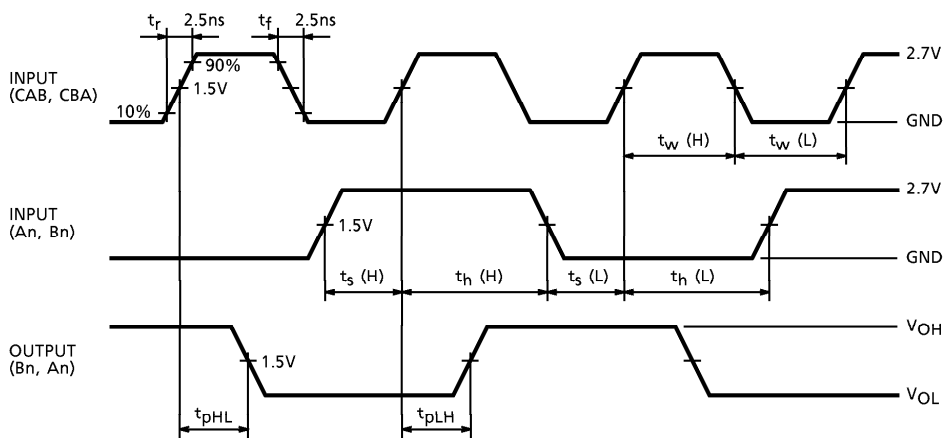

Fig.5 t_{pLH} , t_{pHL} , t_w , t_s , t_h



OUTLINE DRAWING

TSSOP56-P-0061-0.50

Unit : mm

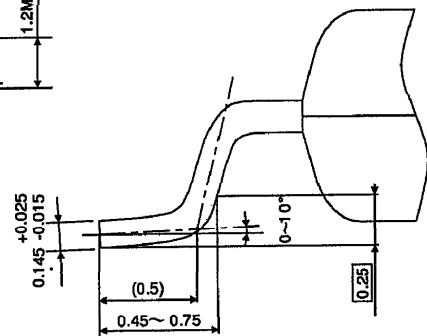
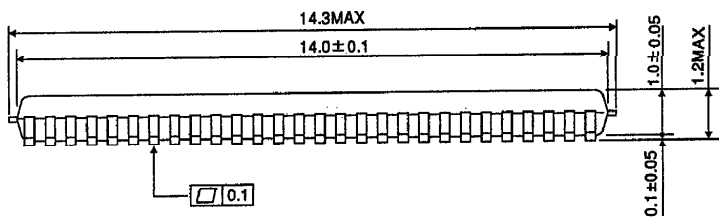
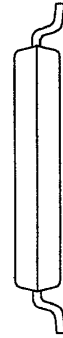
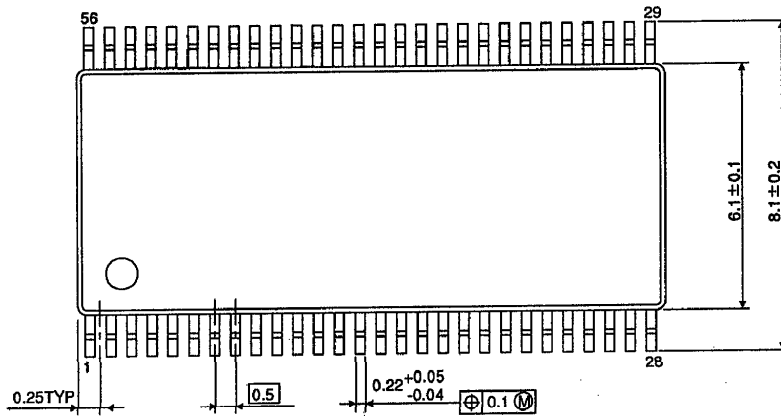

Weight : 0.25g (Typ.)